

# User's Guide

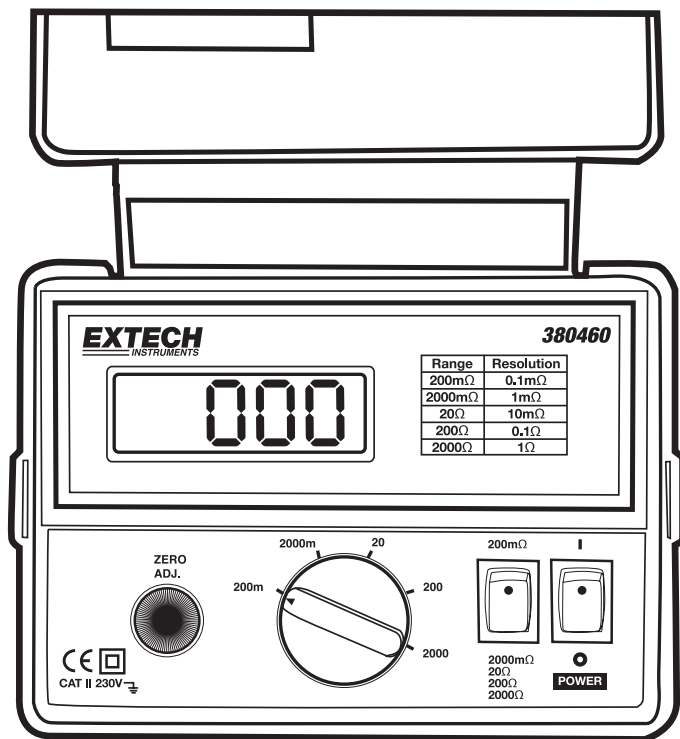

## Precision Milliohm Meters

### Models 380460 and 380462



### Introduction

Congratulations on your purchase of the Extech Milliohm Meter Model 380460 (110V) or Model 380462 (220V). The milliohm meters are enclosed in rugged carrying cases for durability. Measurements are made with Kelvin test leads (supplied) for optimal accuracy in five (5) selectable ranges. Careful use of this meter will provide years of reliable service.

# Specifications

---

## General Specifications

---

displayCircu2000      in      CUSI0m one-chip, SI microprocessor circuit

## Meter Description

1. LCD Display
2. Zero adjust knob
3. Range Dial
4. Power switch
5. 200mΩ select switch
6. AC power cord
7. Kelvin lead to meter connections
8. Carrying case

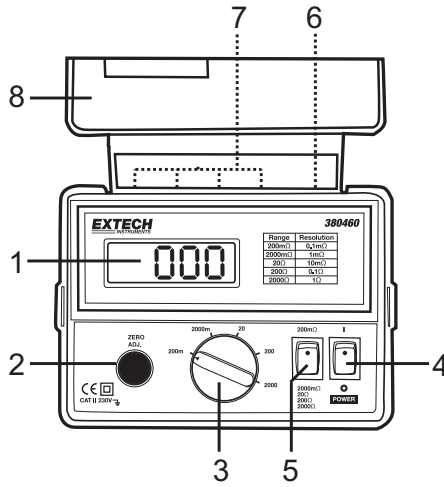

## Operation

### Basic Principles of 4-wire Measurements

For each range, the meter provides a specific amount of test current (refer to General Specifications) which flows from the HI to the LO meter terminal and therefore from the HI to the LO clip lead (Refer to the diagram). This is the current that ultimately passes through the device under test (RX in diagram below).

Once the test current is applied to the device under test, clip leads Rx1 & Rx2 measure the voltage drop across the device under test. The following equations detail how the meter accomplishes its measurement tasks.

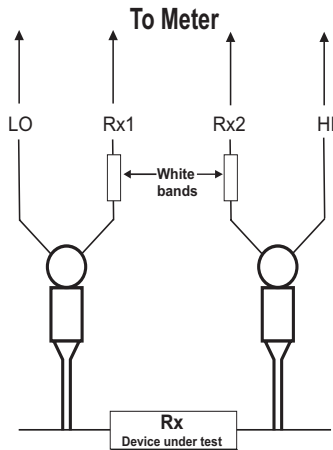







## Measurement Equations

$$V_x = I_s \times R_x;$$

Where  $V_x$  is the voltage (measured by the meter) across the device under test;  $I_s$  is the test current;  $R_x$  is the resistance of the device under test. From  $V_x = I_s \times R_x$ , the meter moves to the next step which is:  $R_x = V_x/I_s$ . With this equation the meter determines the resistance of the device under test. Note that the measured resistance ( $R_{x1}$  &  $R_{x2}$ ) is not affected by stray resistance since the test current is supplied directly to the device under test. This is the advantage of the 4-wire Kelvin lead configuration over 2-wire methods which introduce errors into low resistance measurements.

## International Symbols

	DC Voltage DC Current		Refer to explanation in owners manual
	AC Voltage AC Current		Dangerous voltage risk of electrical shock
	Ground		Double Insulation

## Powering the Meter

Connect the meter to the correct power source (110 or 220VAC); the Model 380460 uses 110VAC and the Model 380462 uses 220VAC (note that these meters are NOT interchangeable). Do not apply voltage to the meter input measurement terminals. Meter damage may result.

## Measurement Procedure

1. Rotate the Range select switch to the 200m range to prepare for zeroing. Ensure that 200m is selected on the 200m select switch.
2. Perform a Zero Adjustment per the following:
  - Short the Kelvin Clips as shown in the diagram below.
  - Rotate the Zero Adjust Knob until the meter indicates zero units.

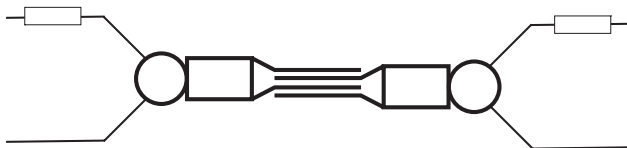

3. Select the desired measuring range via the rotary Range select switch. When using the 200m range, put the 200m select switch to the 200m position; for all other measurements put this switch in the opposite position.
4. Either clip the leads onto a component or clip the leads between two points in a circuit.
5. Observe the meter reading.

## Warranty

---

**EXTECH INSTRUMENTS CORPORATION** warrants this instrument to be free of defects in parts and workmanship for **one year** from date of shipment (a six month limited warranty applies to sensors and cables). If it should become necessary to return the instrument for service during or beyond the warranty period, contact the Customer Service Department at (781) 890-7440 ext. 210 for authorization or visit our website [www.extech.com](http://www.extech.com) for contact information. A Return Authorization (RA) number must be issued before any product is returned to Extech. The sender is responsible for shipping charges, freight, insurance and proper packaging to prevent damage in transit. This warranty does not apply to defects resulting from action of the user such as misuse, improper wiring, operation outside of specification, improper maintenance or repair, or unauthorized modification. Extech specifically disclaims any implied warranties or merchantability or fitness for a specific purpose and will not be liable for any direct, indirect, incidental or consequential damages. Extech's total liability is limited to repair or replacement of the product. The warranty set forth above is inclusive and no other warranty, whether written or oral, is expressed or implied.

## Calibration and Repair Services

---

Extech offers repair and calibration services for the products we sell. Extech also provides NIST certification for most products. Call the Customer Service Department for information on calibration services available for this product. Extech recommends that annual calibrations be performed to verify meter performance and accuracy. **annual calibration E2744 -115 d0 d( )j0 ( )j2108 -11d(( 2es)(0e)j(s )j1949750 d(y)j4j-7**



**Support line (781) 890-7440**

Technical support: Extension 200; E-mail: [support@extech.com](mailto:support@extech.com)

Repair & Returns: Extension 210; E-mail: [repair@extech.com](mailto:repair@extech.com)

**Product specifications subject to change without notice**

For the latest version of this User's Guide, Software updates, and other up-to-the-minute product information, visit our website: [www.extech.com](http://www.extech.com)  
Extech Instruments Corporation, 285 Bear Hill Rd., Waltham, MA 02451