

Introduction

Congratulations on your purchase of the Extech Model 382075 Auto Range Power Clamp-On Meter. This meter is shipped fully tested and calibrated and, with proper use, will provide years of reliable service.

Warranty

EXTECH INSTRUMENTS CORPORATION warrants this instrument to be free of defects in parts and workmanship for **one year** from date of shipment (a six month limited warranty applies to sensors and cables). If it should become necessary to return the instrument for service during or beyond the warranty period, contact the Customer Service Department at (781) 890-7440 ext. 210 for authorization or visit our website www.extech.com for contact information. A Return Authorization (RA) number must be issued before any product is returned to Extech. The sender is responsible for shipping charges, freight, insurance and proper packaging to prevent damage in transit. This warranty does not apply to defects resulting from action of the user such as misuse, improper wiring, operation outside of specification, improper maintenance or repair, or unauthorized modification. Extech specifically disclaims any implied warranties or merchantability or fitness for a specific purpose and will not be liable for any direct, indirect, incidental or consequential damages. Extech's total liability is limited to repair or replacement of the product. The warranty set forth above is inclusive and no other warranty, whether written or oral, is expressed or implied.

Calibration and Repair Services

Extech offers repair and calibration services for the products we sell. Extech also provides NIST certification for most products. Call the Customer Service Department for information on calibration services available for this product. Extech recommends that annual calibrations be performed to verify meter performance and accuracy.



Support line (781) 890-7440

Technical support: Extension 200; E-mail: support@extech.com

Repair & Returns: Extension 210; E-mail: repair@extech.com

Product specifications subject to change without notice

For the latest version of this User Guide, Software updates, and other up-to-the-minute product information, visit our website:

www.extech.com

Table of Contents

Safety	4
Meter Functional Description	5
Operating Instructions	6
AC/DC Voltage Measurements	6
AC/DC Current Measurements	7
AC/DC 1 ϕ 2W Power (W) and Power Factor (PF) measurements	7
AC/DC 1 ϕ 2W Apparent/Reactive Power Measurements (KVA+KVAR)	8
Phase Angle Measurements	8
3 ϕ Balanced Power Measurements	9
3 ϕ 3W Unbalanced Power Measurements	10
3 ϕ 4W Unbalanced Power Measurements	11
1 ϕ 3W Power Measurement	13
Calculation of 3 ϕ 4W Power Factor (PF)	14
Improving the Power Factor of a 3 ϕ 4W Power System	14
Improving the Power Factor of a 3 ϕ Balanced Power System	14
Improving Power Factor of a 1 ϕ 2W Power System	14
Phase Sequence Indication	15
Recording Data	15
Recalling Data from Memory	15
Specifications	16
Battery Replacement	18

Safety

International Safety Symbols



This symbol, adjacent to another symbol or terminal, indicates the user must refer to the manual for further information.



This symbol, adjacent to a terminal, indicates that, under normal use, hazardous voltages may be present



Double insulation

Safety Notes

- Do not exceed the maximum allowable input range of any function.
- Set the function switch OFF when the meter is not in use.
- Remove the battery if meter is to be stored for longer than 60 days.

Warnings

- Set function switch to the appropriate position before measuring.
- Do not measure current on a circuit whose voltage exceeds 600V.
- When changing ranges always disconnect the test leads from the circuit under test.

Cautions

- Improper use of this meter can cause damage, shock, injury or death. Read and understand this user manual before operating the meter.
- Always remove the test leads before replacing the battery.
- Inspect the condition of the test leads and the meter itself for any damage before operating the meter. Repair or replace any damage before use.
- Use great care when making measurements if the voltages are greater than 25VAC rms or 35VDC. These voltages are considered a shock hazard.
- Voltage checks on electrical outlets can be difficult and misleading because of the uncertainty of connection to the recessed electrical contacts. Other means should be used to ensure that the terminals are not "live".
- If the equipment is used in a manner not specified by the manufacturer, the protection provided by the equipment may be impaired.

Function	Input Protection
A AC, A DC	3000A DC/AC
V AC	750V AC
V DC,	1000V DC

Meter Functional Description

1. Transformer Jaw

Used to sense current signal. To measure current or power, the conductor under test must be fully enclosed by the jaw.

2. Transformer Trigger

Press to open the jaw.

3. Data Hold Button

Press to freeze most recent reading on the LCD. Press again to release.

4. Function Select and On/Off Switch

Select desired function, such as KW, V, A, KVA, or 3 ϕ .

5. LCD Display

4-digit (9999 count) display with function symbols, units, decimal point, low battery icon, and zero indication.

6. Units Symbols

Once a function is selected, the corresponding unit (KW, V, A, Phase, KVA, or 3 ϕ) will be displayed.

7. 3 ϕ W and 3 ϕ 4W Select Button

If the 3 ϕ system is not a balanced system, users can press this button to select 3 ϕ 3W, 3 ϕ 4W or a balanced system. Once the button is pressed, the LCD displays 3 ϕ 3W or 3 ϕ 4W depending on the function selected.

8. Read/Next Button

- When the rotary switch is set to the 3 ϕ function, the READ/NEXT button is used as a NEXT button. In the 3 ϕ balanced mode, pressing the NEXT button will display W+PF, KVA+KVAR, or V+A data.
- In the 3 ϕ 3W mode, pressing the NEXT button stores the measured values $W_{RS(L1L2)}$ and $W_{TS(L3L2)}$. After two values are measured and stored, the meter adds the two values, displays the result with the symbol W_{RST} to represent $W_{3\phi 3W}$. To start another $W_{3\phi 3W}$ measurement, press the NEXT button again.
- In the 3 ϕ 4W system mode, press the NEXT button to store the measured values $W_R(L1)$, $W_S(L2)$ and $W_T(L3)$. After three values are measured and stored, the meter adds the three values, displays the result with the symbol W_{RST} to represent $W_{3\phi 4W}$. To start another $W_{3\phi 4W}$ measurement, press the NEXT button again.
- If the rotary switch is not set to the 3 ϕ function, the READ/NEXT button is used as a READ button. Stored data in memory (saved by pressing the REC button) can be read by pressing READ.

9. & 10. V and COM Input Terminals

Used as positive and negative (common) inputs for voltage measurements.

11. DC A/W ZERO button

Press this button once to zero the Amp or Watt display. While the meter is zeroing, the word ZERO appears the LCD.

12. REC button

Press the REC button to store up to 4 data points in meter memory.

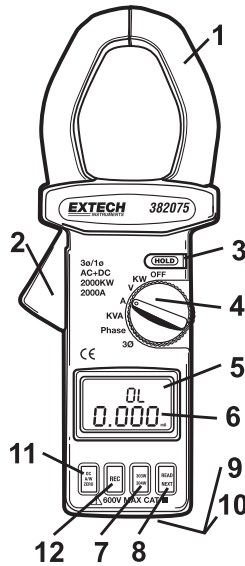

Operating Instructions

NOTE: Ensure that the jaws are clear of any conductors before applying power to the meter. The meter performs an auto zero upon power-up to null any residual magnetism. If this is done with a conductor inside the jaw area, the auto zero function will cause subsequent measurements to be inaccurate.

AC/DC Voltage Measurements

Voltage (V) and Frequency (Hz) Dual Display

WARNING: Maximum input voltages: 1000VDC and 750VAC. Do not attempt to measure voltage that exceeds these limits.

1. Set the rotary switch to the Voltage position (V).
2. Insert the test leads into the input terminals.
3. Connect the test leads in PARALLEL with the circuit to be measured.
4. The power clamp will automatically select the proper range.
5. Read the voltage and Frequency values displayed on the LCD.

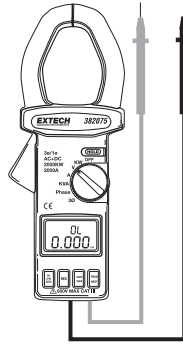

NOTE: The sensitivity for voltage/frequency measurements is 1V, and the frequency range is 10 - 400Hz. If the frequency is < 10 Hz, the LCD will indicate 0 Hz. If the frequency is > 400 Hz, LCD will show OL.

Voltage(V) / Current (A) Dual Display

Follow the instructions in the section entitled "3 ϕ Balanced Power Measurements" to monitor V and A simultaneously.



AC/DC 1 ϕ 2W Apparent/Reactive Power Measurements (KVA+KVAR)

NOTE: Before taking any measurements, zero the current (A) reading and set the rotary switch to the KVA position.

Follow the steps listed in section entitled DC+AC 1 ϕ 2W Power (W) and Power Factor (PF) measurement for these measurements. KVAR is a calculated value, and its accuracy greatly depends on the accuracy of the V, A, and KW readings. To obtain a more accurate KVAR value when PF is greater than 0.91 ($\phi < 25^\circ$), measure the phase angle and obtain the KVAR from the following equation for a pure sine wave:

$$\text{KVAR} = \text{KVA} * \sin \phi$$

Phase Angle Measurements

1. Set the rotary switch to the A position. If the current reading is not zero, press the DCA ZERO button.
2. Set the rotary switch to the Phase position.
3. Insert the test leads into the input jacks.
4. Connect the test lead inserted in the COM (black) terminal to the reference line.
5. Connect the test lead connected to the V (red) terminal to the voltage signal under test.
6. Clamp on to the wire where the V (red) terminal is connected.
7. If current signal is detected from the jaws, the phase angle will be displayed in degrees on the LCD together with the frequency of the voltage.
8. If current is not detected, only the frequency of the voltage will be displayed while the phase angle display will be left blank.

INDUCTIVE LOAD: A negative phase angle indicates that the current signal lags the voltage signal. A negative phase angle also indicates an inductive load.

CAPACITIVE LOAD: A positive phase angle indicates that the current signal leads the voltage signal. A positive phase angle also indicates a capacitive load.

NOTE: The "+" sign printed on the clamp jaw must face the power source for correct readings.

3 ϕ Balanced Power Measurements

Power (W) and Power Factor (PF) Dual Display

1. Apply power to the meter with the jaw clear of any conductors.
2. Set the rotary switch to the 3 ϕ position.
3. The LCD will show 3 ϕ 3W, 3 ϕ 4W, and BAL symbols to indicate balanced mode.
4. If the watt reading is not zero, press the DCA/DCW ZERO button once to zero reading
5. Insert the test leads into the input terminals.
6. Select one phase (R or L1) as COM and Connect the COM (black) terminal to the same phase just selected (R or L1).
7. Connect another test lead to the second phase (S or L2).
8. Clamp on to the third phase (T or L3).
9. The power clamp will automatically select proper range.
10. Read the Watt and PF values displayed on the LCD.
11. To view the KVA and KVAR data, press the NEXT button.
12. To view V and A, press the NEXT button again.
13. To return to the W and PF display, press the NEXT button again.

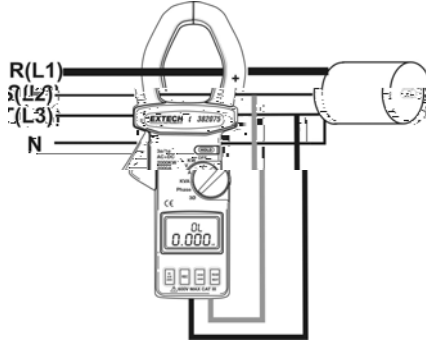

KVA/KVAR Dual Display

Follow steps 1 through 10. in the above section and press the NEXT button. Wait approx. 2 seconds for the LCD to display the KVA and KVAR.

Voltage (V) and Current (A) Dual Display

Follow steps 1 through 10 in the above section and press the NEXT button twice. Wait approx. 2 seconds for the LCD to display Voltage (V) and Current (A).

NOTE: Specific selection of each phase is not required in 3 ϕ balanced power measurement mode. As long as each test lead and the jaws are connected to different phases, the reading is always correct. The "+" sign printed on jaw must face the power source for accurate measurement.

NOTE: To find out if a load is capacitive or inductive, refer to the section entitled "Phase Angle Measurements".

3 ϕ 3W Unbalanced Power Measurements

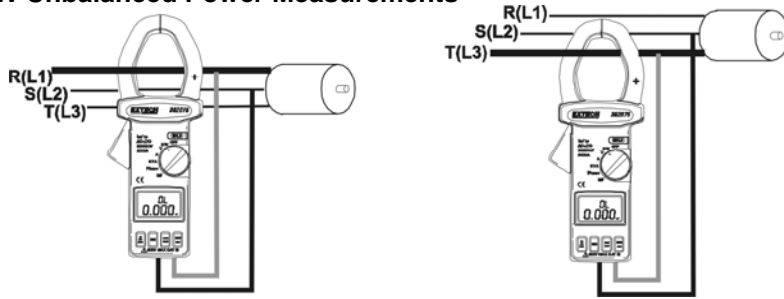

$$W_{3\phi W} = W_{RST} = W_{RS(L1L2)} + W_{TS(L3L2)}$$

Two measurements W_{RS} (or W_{L1L2}) and W_{TS} (or W_{L3L2}) are required.

1. Measure W_{RS} (or W_{L1L2})

- a. Apply power to the meter with the jaw clear of any conductors.
- b. Set the rotary switch to the 3 ϕ position.
- c. Press the 3 ϕ button once, the 3 ϕ W symbol will display on the LCD. At this moment, the W_{RS} symbol flashes prompting the user to begin measurement of W_{RS} .
- d. If the watt reading is not zero, press the DCA/DCW ZERO button once to zero reading
- e. Insert the test leads into the input terminals.
- f. Select one phase (S or L2, for example) as COM and connect the COM (black) terminal to that phase (S or L2).
- g. Connect V (red) terminal to the second phase (R or L1).
- h. Clamp on to the same phase as in step g. (R or L1).
The power clamp will automatically select the proper range.
- i. Wait until the reading stabilizes, then press the NEXT button. The W_{RS} (W_{L1L2}) symbol will disappear. At this moment, W_{RS} is stored in memory, and the W_T (W_{L3L2}) symbol appears flashing to prompt the user to take the W_{TS} (W_{L3L2}) measurement.

2. Measure W_{TS} (or W_{L3L2}).

- a. Disconnect the test leads and jaws from the lines in the previous measurement.
- b. Connect the test leads to the third phase (T or L3).
- c. Open and close the jaws, be sure that no conductor is in the jaws.
- d. If the watt reading is not zero, press the DCA/DCW ZERO button once to zero the reading.
- e. Clamp on to the third phase where the test lead is connected (T or L3)
- f. The power clamp will automatically select proper range.
- g. Wait until the reading stabilizes, then press the NEXT button. The W_T (or W_{L3L2}) symbol will disappear. At this moment, W_{TS} (or W_{L3L2}) data are stored in memory,

Once the NEXT button is pressed (after measurements of W_{RS} (or W_{L1L2}) and W_{TS} (or W_{L3L2}), the power clamp will add the two values and display the result on the LCD. The W_{RST} symbol appears indicating that the reading shown is the wattage of the 3 ϕ 3W unbalanced Power. PF is not shown in the 3 ϕ 3W unbalanced power mode.

NOTE: Once a phase is selected as the COMMON connection, users cannot change this selection in the subsequent measurements. For example, if S (or L2) phase is selected, S (or L2) phase is always connected to the COM of the power clamp during measurements of W_{RS} (or W_{L1L2}) and W_{TS} (or W_{L3L2}) in 3 ϕ 3W unbalanced power mode.

NOTE: The "+" sign printed on the jaw must face the power source.

NOTE: In the 3 ϕ

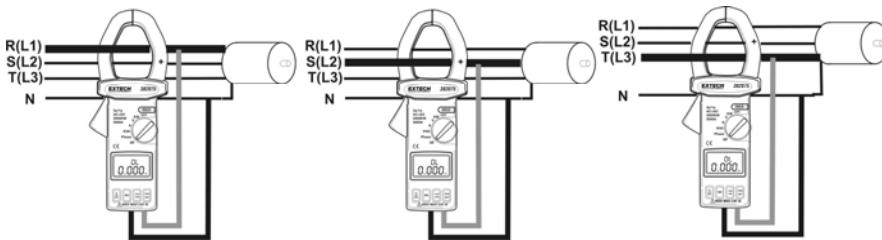

2. Measure W_S (L2).

- a. Connect the V (red) test lead to the second phase S (L2).
- b. If the watt reading is not zero, press the DCA/DCW ZERO button once to zero reading
- c. Clamp on to the second phase S (L2)
- e. The power clamp will automatically select the proper range.
- f. Wait until the reading stabilizes, then press the NEXT button. The W_S symbol will disappear. W_S is now stored in memory.

3. Measure W_T (L3).

- a. Connect the V (red) test lead to the third phase T (L3).
- b. If the watt reading is not zero, press the DCA/DCW ZERO button once to zero reading.
- d. Clamp on to the third phase T (L3).
- e. The power clamp will automatically select the proper range.
- f. Wait until the reading stabilizes, then press the NEXT button. The W_T symbol will disappear and W_T will be stored in memory,

4. Once the NEXT button is pressed (after measurements of W_R , W_S , and W_T), the power clamp will add the three values W_R , W_S , and W_T together and display the result on the LCD. The $WRST$ symbol will appear indicating that the reading shown is the wattage of the $3\phi 4W$ unbalanced circuit. PF is not shown in the $3\phi 4W$ unbalanced power measurement mode.

NOTE: The "+" sign printed on jaw must face the power source.

NOTE: In the $3\phi 4W$ unbalanced power measurement mode, all three W_R or W_S and W_T readings must be positive. If one is negative, check the connection of the test leads and the clamping of jaw. Make sure test lead and clamp connections are correct to obtain useful power readings.

1 ϕ 3W Power Measurement

1 ϕ 3W power measurements are similar to 3 ϕ 3W unbalanced power measurements except that the nomenclature is different. Two measurements of W_{RS} (or W_{L1G}) and W_{TS} (or W_{L2G}) are required

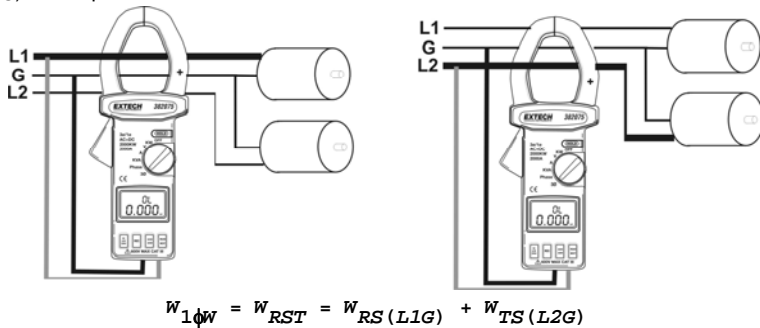

1. Measure W_{RS} (or W_{L1G}).
 - a. Apply power to the meter with the jaw clear of any conductors
 - b. Set the rotary switch to the 3 ϕ position.
 - c. Press the 3 ϕ button once, and the 3 ϕ 3W symbol only will appear on the left side of the LCD. The W_{RS} symbol will flash prompting the user to measure $W_{RS(L1G)}$.
 - d. If the watt reading is not zero, press the DCA/DCW ZERO button once to zero it.
 - e. Insert the test leads into the input terminals.
 - f. Connect the COM (black) terminal to ground.
 - g. Connect the V (red) terminal to the second phase (L1).
 - h. Clamp on to the same phase as connected in step g. (L1).
 - i. The power clamp will automatically select the proper range.
 - j. Wait until the reading stabilizes, then press the NEXT button. The W_{RS} (W_{L1G}) symbol will disappear and the $W_{RS(L1G)}$ reading will be stored in memory. The W_T (W_{L2G}) symbol will flash prompting the user to take W_{TS} (W_{L2G}) measurements.
2. Measure W_{TS} (or W_{L2G}).
 - a. Disconnect the test leads from the phase where the jaws were clamped onto in the previous measurement.
 - b. Connect the test lead to the L2 line.
 - d. If the watt reading is not zero, press the DCA/DCW ZERO button once to zero reading
 - e. Clamp on to the L2 line where the test lead is connected.
 - f. The power clamp will automatically select the proper range.
 - g. Wait until the reading is stable, then press the NEXT button. The W_T (or W_{L2G}) symbol will disappear. At this moment, W_{TS} (or W_{L2G}) is stored in the memory,
3. Once the NEXT button is pressed after measurements of W_{RS} (or W_{L1G}) and W_{TS} (or W_{L2G}) are taken, the power clamp will add the two values together and show the result on the LCD. The W_{RST} symbol will display along with the wattage of the 1 ϕ 3W unbalanced Power. PF is not shown in 1 ϕ 3W unbalanced power mode. See equation below.

Calculation of 3 ϕ 4W Power Factor (PF)

When measuring 3 ϕ 4W unbalanced power, use the REC button to record the individual power factors ($KW_{R(L1)}$, $PF_{R(L1)}$, $KW_{S(L2)}$, $PF_{S(L2)}$, $KW_{T(L3)}$, and $PF_{T(L3)}$) of each phase in memory. 3 ϕ 4W power factor can be calculated using the following equation:

$$KVA_{R(L1)} = \frac{KW_{R(L1)}}{PF_{R(L1)}}; KVA_{S(L2)} = \frac{KW_{S(L2)}}{PF_{S(L2)}}; KVA_{T(L3)} = \frac{KW_{T(L3)}}{PF_{T(L3)}}$$

$$KVA_{3\phi W} = KVA_{R(L1)} + KVA_{S(L2)} + KVA_{T(L3)}$$

$$PF_{3\phi W} = \frac{KW_{3\phi W}}{KVA_{3\phi W}}$$

Improving the Power Factor of a 3 ϕ 4W Power System

Measure the $KVAR_R$ (or $KVAR_{L1}$), $KVAR_S$ (or $KVAR_{L2}$), and $KVAR_T$ (or $KVAR_{L3}$) values of each phase. Based upon the measured values, a 3 ϕ or 1 ϕ capacitor at the rated voltage and frequency can be used to improve the power factor. To find the value of capacitance, refer to the following equation.

$$Capacitance (Farad) = \frac{KVAR * 1000}{2\pi f V^2}$$

Where:

f : frequency in Hz

V : phase voltage

It is recommended that the KVAR value of the capacitor a somewhat less than the value measured.

Improving the Power Factor of a 3 ϕ Balanced Power System

1. Measure the KVAR 3 ϕ value of a balanced system.
2. Based upon the measured value, a 3 ϕ capacitor at the rated voltage and frequency can be used to improve power factor.
3. To find the value of capacitance, refer to the equation in the section above.
4. It is recommended that the KVAR value of the capacitor be somewhat less than the value measured.

Improving Power Factor of a 1 ϕ 2W Power System

1. Measure KVAR value of a 1 ϕ 2W power system.
2. Based upon the measured value, users can purchase required capacitor at rated voltage and frequency to improve power factor.
3. If value of capacitance is needed, obtain the value via the equation in the section entitled "Improving Power Factor of 3-phase 4-wire System".
4. It is recommended that the KVAR value of the capacitor should be a little less than the value measured.

NOTE: The indication of phase sequence is not limited to 3 ϕ balanced power. It can be used in general as long as the Power Factor is greater than 0.1.

Phase Sequence Indication (for Power Factor > 0.1)

In the 3 ϕ balanced power mode the meter will automatically detect the phase relationship between three individual phases.

1. Set the rotary switch to the 3 ϕ position.
2. Connect the voltage input (red terminal) to the 'R' (L1) phase, connect the COM input (black terminal) to the 'S' (L2) phase, and clamp on the 'T' (L3) phase. When clamping onto the 'T' (L3) phase, the power clamp must face the power source.
3. If the phase sequence is clockwise, R, S, T sequence will flash on the display.
4. If the phase sequence is counterclockwise, T, S, R sequence will flash.
5. If current is not detected, only one of the R, S or T phases will be displayed on the LCD.

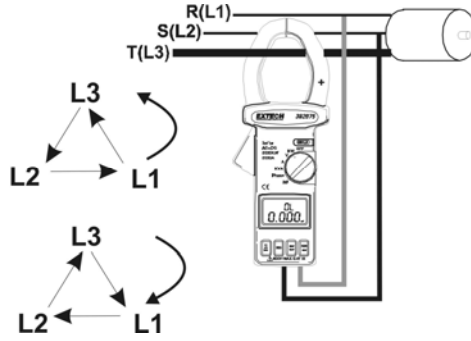

NOTE: The "+" sign printed on jaw must face the power source for correct measurement.

Recording Data

The power clamp can store 4 data points in memory. To store data displayed on the LCD, press the REC button. If the power clamp already has 4 data points memorized, the LCD will display FULL. The REC symbol will be displayed on the LCD if any data is currently stored in memory. To clear the meter memory, power the meter down.

Recalling Data from Memory

To retrieve data from memory, press the READ button. **NOTE:** The rotary switch must not be set to the 3 ϕ function when reading memory data. Once the READ button is pressed, the reference number of the data will be displayed first; the stored measurement data will then be displayed. While in the READ mode, the REC. and No. symbols will be displayed on the LCD. To exit the READ function, select another function using the rotary switch.

NOTE: If both the REC and the No. symbols are shown on LCD, the reading shown on the LCD is the data stored in memory, not actual measurement data.

Specifications

General Specifications

Conductor Size	Cable Φ 55mm. (approx.) Bus Bar 65mm (D) x 24mm (W)
Display	Dual 4-digit 9999 count LCD
Sampling time	0.5 seconds for Voltage and Current; 1.6 seconds for Watts
Overload Indication	'OL' displayed on LCD
Power	9V Battery (Heavy Duty Type)
Power consumption	Approx. 28mA
Operating conditions	4°C to 50°C <85% RH
Dimensions	10.7" (L) x 4.4" (W) x 1.8" (H) 271mm (L) x 112mm (W) x 46mm (H)
Weight	22.8 oz. / 647g (with battery)
Safety	For indoor use and in accordance with the requirements for double insulation to IEC1010-1 (2001): EN61010-1 (2001) Overvoltage Category III 600V and Category II 1000V, Pollution Degree 2.

AC/DC KW True Power (PF 0.2 - 1.0, 3 ϕ 3W, 3 ϕ 4W, 1 ϕ 2W, and 1 ϕ 3W) Balanced

Range	Resolution	Accuracy (of reading)	Maximum Input	
			Current	Voltage
0 - 99.99KW	0.01KW	\pm 2.0% \pm 0.5KW	200A	500V AC/DC
100.0 - 999.9KW	0.1KW	\pm 2.0% \pm 0.5KW	2000A	600VAC 800VDC
1000-1200KW	1KW	\pm 2.0% \pm 5KW		

AC/DC Voltage (True RMS, Crest Factor < 4, Autorange, Overload Protection 800VAC)

Range	Resolution	Accuracy (of reading)		Input Impedance
		DC, 50 / 60 Hz	40 - 400Hz	
0-200V	0.1V	\pm 1.5% \pm 5dgts	\pm 2.0% \pm 5dgts	10M Ω
200-500V	0.1V	\pm 1.5% \pm 5dgts	\pm 2.0% \pm 5dgts	
500 - 600VAC 500 - 800VDC	1V	\pm 1.5% \pm 5dgts	\pm 2.0% \pm 5dgts	

AC/DC Current (True RMS, Crest Factor < 4):

Range	Resolution	Accuracy (of rdg)		Overload Protection
		DC, 50 / 60 Hz	40 - 400Hz	
0 - 200A	0.1A	±1.5% ±5dgt	±2.0% ±5dgt	AC 3000A
200 - 500A	0.1A	±2.0% ±5dgt	±2.5% ±5dgt	
500-2000A	1A	±2.5% ±5dgt	±3.0% ±5dgt	

AC/DC KVA (Apparent Power)

$KVA = V * A / 1000$

AC KVAR (Reactive Power, PF < 0.91)

Range	Resolution	Accuracy	Remark
0 to 1200KVAR	0.1	1 KVAR or ±3%rdg+9d (whichever is greater)	For more information, refer to the section entitled "DC/AC 1φ2W Apparent/Reactive Power measurements"

Phase Angle (User must zero the current reading before taking measurements)

Range	Accuracy	Sensitivity	Remark
-90° to +90°	± 2.0°	V > 100V, A > 10A	Zero Crossing Detection

Note: If current signal is not detected, the phase angle will be left blank in LCD.

Frequency (if < 10 Hz, then the Hz Display = 0)

Range	Accuracy	Sensitivity
50/60 Hz	±2 dgts	V > 1V, A > 5A
10 - 400 Hz	0.5% ± 2dgt	

Power Factor (PF)

Range	Max. Resolution	PF = KW / KVA
0.2 to 1	0.01	

Battery Replacement

When the low battery symbol appears on the LCD, replace the 9V battery.

1. Remove power to the meter and disconnect all test lead and jaw connections.
2. Remove the screws from the bottom of the meter housing.
3. Lift and remove the meter battery compartment.
4. Replace the 9V battery.
5. Replace the case and secure the screws.

Copyright © 2006 Extech Instruments Corporation

All rights reserved including the right of reproduction in whole or in part in any form.

airconcern

more info for Extech 382075

Phone: 01235 838 555

Email: cs@airconcern.co.uk

Web: www.airconcern.co.uk

Air Concern Ltd, Building 173 Curie Avenue Harvell Didcot, Oxfordshire