

User's Guide

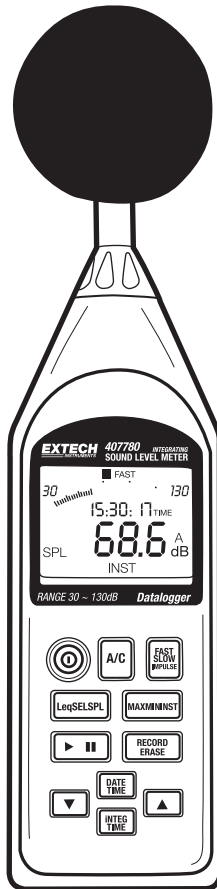

Integrating Sound Level Datalogger

Model 407780



Introduction

Congratulations on your purchase of the Extech 407780 Integrating Sound Level Meter. The 407780 with programmable integrating time provides precise linearity over a wide range (100dB) and displays Leq, SEL, SPL, MAX-L, and MIN-L measurements. Response time (FAST, SLOW, and IMPULSE) and frequency weighting (A and C) are programmable. The analog output (AC and DC) can be used with headphones, chart recorders or other devices to PC. The 407780 with PC Interface and real-time calendar clock datalogs (stores) up to 32,000 readings for later transfer to PC. Careful use of this meter will provide years of reliable service.

Meter Description

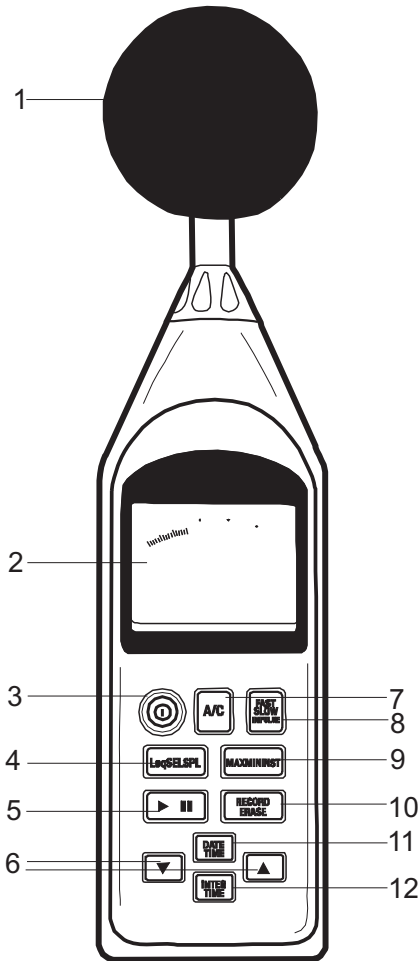

Refer to the diagram on the facing page:

1. 1/2-inch microphone (shown with windscreen)
2. LCD display
3. Power Switch
4. Leq / SEL / SPL select switch
5. RUN / Pause switch
6. Use the UP/DOWN arrow keys to change the measurement preset time.
7. A / C Frequency weighting select switch
8. FAST / SLOW / IMPULSE time weighting select switch.

FAST: 125ms

SLOW: 1 second

IMPULSE: 35ms with slow decay

9. Press to select MAX MIN recording. Press again to step through MAX and MIN values. Press and hold for 3 seconds to erase the MAX and MIN values and exit this mode.

10. RECORD / ERASE

Record standby: The RECORD symbol appears in standby mode.

Recording: The RECORD symbol flashes once per second while recording.

Erase data: Press & hold the RECORD/ERASE key for 3 seconds to erase data (the entire LCD will flash three times).

11. Real time clock with calendar
12. Measuring time selection for Leq and SEL
13. RS-232 interface connector (Located on bottom, not shown)
14. AC output terminal (located on side, not shown)
2 Vrms at 130dB
Output impedance 600Ω Max.
Output signal uses standard 3.5mm phono jack (supplied). Signal on tip; ground on sleeve.
15. DC output terminal (located on side, not shown)
Output: 10mV/dB
Output impedance 100Ω max.
Output signal uses standard 3.5mm phono jack (supplied). Signal on tip and ground on sleeve.
16. CAL (calibration) potentiometer (located on side, not shown)
17. External DC 6V power supply terminal (located on side, not shown)
18. Tripod mounting screw (located on rear, not shown)
19. Battery cover (located on rear, not shown)

Display Description

1. Level range
2. Date information
3. Leq: Equivalent continuous
4. SEL: Sound exposure level
5. SPL: Instantaneous sound pressure level
6. Low-Battery indicator
7. MAX: Maximum SPL value is held during measurement.
8. MIN: Minimum SPL value is held during measurement.
9. INST: Instantaneous of sound pressure level
10. Data recording
11. Measuring value
12. Memory full
13. Unit
14. Frequency weighting (A/C)
15. IMPULSE time weighting
16. When the TIME display icon switches on, the real time clock is displayed. When the TIME icon is off the display shows elapsed time for Leq and SEL measurements.
17. Bargraph (100dB range with 50 segments)
18. Range over
19. SLOW time weighting
20. FAST time weighting
21. Measurement completion of Leq and SEL
22. Measurement interruption of Leq and SEL
23. Leq and SEL readings
24. Under Range

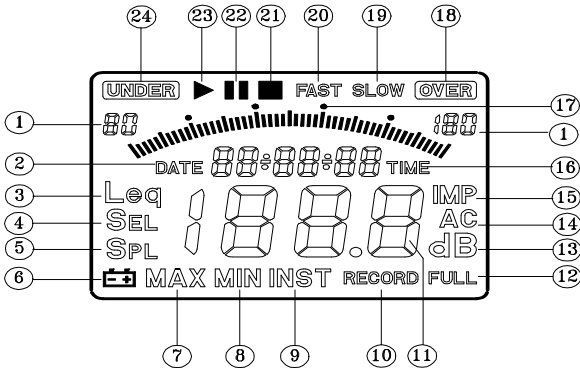

Operation

This meter can be used in two different manners. As an **Integrating Sound Level Meter** or as a **Sound Pressure Meter (SPL)**.

Integrating Sound Level Meter

LEQ Mode

In the **LEQ** mode the display indicates the integrated (average) level for the run period. If no run time has been accumulated the display shows dashes.

Taking Measurements

1. Turn the meter on by pressing the **green on/off** button.
2. Select the LEQ mode by pressing the **Leq SEL SPL** button until LEQ appears on the LCD.
3. Select the desired Frequency Weighting as needed (A or C).
Change the Frequency Weighting by pressing the **'A/C'** button. The 'A' or 'C' icon will display on the right-hand area of the LCD.
4. Select the desired Response Time as needed (Fast or Slow)
Change the Response Time by pressing the **'FAST/SLOW/IMPULSE'** button. The 'FAST' 'SLOW' icon will display on the upper area of the LCD.
5. Select the desired Run Time. There are 13 preset time settings available (To perform a manual recording select the 24 hour interval.)

1 second	3 seconds	10 seconds	30 seconds	1 minute
5 minutes	8 minutes	10 minutes	30 minutes	15 minutes
30 minutes	1 hour	8 hours	24 hours	

Change the run time by pressing the **INTEG TIME** button. The run time will appear in the middle of the LCD. Press the **▲** or **▼** button to select the preset time setting.

6. Hold the instrument comfortably in hand and away from your body or position it on a tripod. Point the microphone toward the noise source
7. Press **▶||** button to begin measuring. The run time counter will zero and begin counting. While running the meter will display **▶** at the top of the display.



The meter will stop automatically after the preset time interval has expired and will display **■** and the LEQ for the recording interval.



To take another LEQ simply press **▶||** again.

It is also possible to record each session. Simply press **RECORD** before pressing **▶||**. The **RECORD** icon will appear on the bottom right of the display and flash while the session is in progress. For instructions on retrieving the recorded data please refer to the software manual on the CD included with your meter.

SEL Mode

In the **SEL** mode (Sound Exposure Level) – the display indicates the constant sound level in decibels which, if lasting for one second, would deliver the same amount of acoustical energy as that delivered over the entire measurement period. If no run time has been accumulated the display shows dashes.

1. Turn the meter on by pressing the **green on/off** button.
2. Select the SEL mode by pressing the **Leq SEL SPL** button until SEL appears on the LCD.
3. Select the desired Frequency Weighting as needed (A or C).
Change the Frequency Weighting by pressing the '**A/C**' button. The 'A' or 'C' icon will display on the right-hand area of the LCD.
4. Select the desired Response Time as needed (Fast or Slow)
Change the Response Time by pressing the '**FAST/SLOW/IMPULSE**' button. The 'FAST' 'SLOW' or IMP icon will display.
5. Select the desired Run Time. There are 13 preset time settings available (To perform a manual recording select the 24 hour interval)

1 second	3 seconds	10 seconds	30 seconds	1 minute
5 minutes	8 minutes	10 minutes	30 minutes	15 minutes
30 minutes	1 hour	8 hours	24 hours	

Change the run time by pressing the **INTEG TIME** button. The run time will appear in the middle of the LCD. Press the **▲** or **▼** button to select the preset time setting.

6. Hold the instrument comfortably in hand and away from your body or position it on a tripod. Point the microphone toward the noise source
7. Press **▶||** button to begin measuring. The run time counter will zero and begin counting. While running the meter will display **▶** at the top of the display.

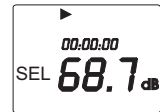

The meter will stop automatically after the preset time interval has expired and will display **■** and the SEL for the recording interval.

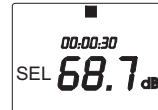

It is also possible to datalog the session. Simply press **RECORD** before pressing **▶||**. The **RECORD** icon will appear on the bottom right of the display and flash while the session is in progress. For instructions on retrieving the recorded data please refer to the software manual on the CD included with your meter.

Sound Pressure Measurements (SPL)

In SPL mode the display shows readings of the sound pressure level.

1. Turn the meter on by pressing the **green on/off** button.
2. Select the SPL mode by pressing the **Leq SEL SPL** button until SPL appears on the LCD.
3. Select the desired Frequency Weighting as needed (A or C).
Change the Frequency Weighting by pressing the **A/C** button. The 'A' or 'C' icon will display on the right-hand area of the LCD.
Note: With 'A' weighting selected, the meter responds like the human ear. 'A' weighting is commonly used for environmental measurements, OSHA regulatory testing, law enforcement, and workplace design. Select 'C' weighting for flat response measurements. 'C' weighting is typically used for the sound level analysis of machines, engines, etc. Most hearing conservation related testing is performed using 'A' Weighting.
4. Select the desired Response Time as needed (Fast, Slow or Impulse).
Change the Response Time by pressing the 'FAST/SLOW/IMPULSE' button. The 'FAST' 'SLOW' or 'IMP' icon will display.
Note: Select FAST to capture noise peaks and noises that occur very quickly. In FAST mode, the meter responds in 125ms. Select the SLOW Mode (meter responds in 1s) to monitor a sound source that has a reasonably consistent noise level or to average quickly changing levels. In IMPULSE mode the meter responds in 35ms and is used to capture sounds such as those produced at a shooting range. Selection of Fast or Slow is determined by the application and any directives or standards related to that application. Most hearing conservation related testing is performed using a SLOW Response Time setting.
5. Hold the instrument comfortably in hand and away from your body or position it on a tripod. Point the microphone toward the noise source, the sound pressure level will be displayed on the meter's LCD display.

MIN/MAX Function

Press the **MAX MIN INST** button to begin capturing the, Maximum (MAX) OR Minimum (MIN) sound values. The display will indicate the MAX or MIN value (depending on which is selected) captured since the MAX/MIN button was pressed. Press and hold the **MAX MIN INST** button to return to the instantaneous reading mode

Note:

When the meter is measuring the following buttons cannot be used:

- FAST, SLOW, IMPULSE
- A/C Weighting
- DATE/TIME
- INTEG TIME
- RECORD ERASE
- UP/DOWN Arrow keys

Setting the Real Time Calendar Clock

1. Start with the meter off. Press and hold the **DATE TIME** button, and while holding the key, press the green **ON/OFF** button to switch the instrument on. Release the power button when the meter flashes three times.
2. A blinking number indicates the currently selected parameter. The first blinking parameter will represent the current year. Use the **UP** and **DOWN** arrow keys to set the correct year.
3. Press the **DATE TIME** button to move to the next parameter (month). Use the arrow keys to set the correct month.
4. Repeat step 3 to set the day, hour, minute, and second.
5. To confirm the new date and time press the **DATE TIME** button. Note that the 407780 has a back-up battery.

Note: The clock can also be set via the accompanying software program. See the software manual on the enclosed CD for the steps on this procedure.

Powering the meter

1. Install the four (4) 'AA' 1.5V batteries in the rear battery compartment. Observe polarity.
2. If the battery level falls low the battery symbol will appear on the LCD. Replace the batteries when the symbol appears.
3. For use of the optional AC Adaptor, plug the adaptor into the side of the meter in the jack labeled '6V' and then into an appropriate AC power source.

Calibration

Calibrating the Model 407780 Integrating Sound Level Datalogger requires an acoustical calibrator such as the Extech Model 407766 or 407744.

1. Configure the meter as follows:
 - Display: SPL (dBA)
 - Time weighting mode: FAST
 - Measurement mode: INST
2. Insert the 407780 microphone into the opening of the acoustical calibrator.
3. Adjust the 407780 calibration potentiometer until the 407780 display matches the acoustical calibrator output signal (typically 94 or 114dB).

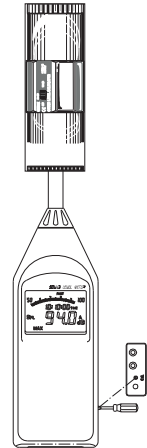

Maintenance & Cleaning

- Service not covered in this manual should be performed by qualified personnel
- Periodically wipe the case with a dry cloth. Do not use abrasives or solvents.

Analog output

The 407780 has two analog output jacks located on its right side; one for AC and one for DC. For DC, the meter transmits 10mv / dB. For AC the full scale value is 0.707V. The output impedance is 600 Ω for AC and 100 Ω for DC.

The supplied 3.5mm stereo mini-plug can be used to assemble a cable to connect to either of the meter's analog output jacks. When using a stereo plug, like the one supplied, short the Tip and the Ring (see diagram below). Ground (negative) connects to the Sleeve while the positive signal is taken from the Tip/Ring. For mono plugs, ground connects to the Sleeve while the positive signal is taken from the Tip. The meter output can then be transmitted to a headset, chart recorder, datalogger, or other data storage device.

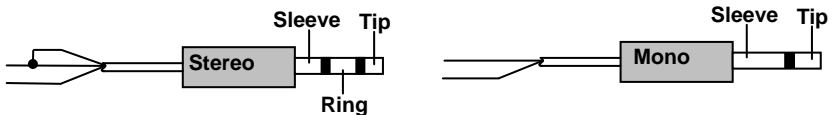

Datalogging

For detailed information on using the software please refer the software manual on the enclosed CD.

The 407780 can store up to 32,000 measurements. To view, save, print, and manipulate the data, the records must be downloaded to a PC. Each recorded data set holds the following information:

96 Completed

Open Print Ln

Value	Time
Date Time=11/17/04 16:19:00	
Sampling Time=5	
Record Num= 96	
Leq Value=92.2	SEL Value=119.0
MAX Value=109.4	
MIN Value=40.0	
Freq Weighting=A	Time Weighting=Slow
52.0,16:19:00,	
67.7,16:19:05,	
67.7,16:19:10,	
57.9,16:19:15,	
59.1,16:19:20,	
58.8,16:19:25,	
56.0,16:19:30,	
59.5,16:19:35,	
65.1,16:19:40,	
49.0,16:19:45,	

Ln

Print

- Date and Time of reading
- Response time and frequency weighting
- Sampling time (rate of data recording)
- Total number of records
- Leq
- Max L
- Min L
- SEL
- Measurement duration

Ln	0	1	2	3	4	5	6	7	8	9
L(00)	108.4	108.1	107.2	90.5	81.3	79.2	78.4	77.1	69.7	67.8
L(10)	67.7	67.7	66.7	65.5	65.2	65.1	63.3	62.8	62.7	62.2
L(20)	61.8	61.4	61.2	60.8	60.7	60.5	60.2	60.2	59.6	59.5
L(30)	59.5	59.1	59.0	59.0	58.9	58.8	58.8	58.5	58.5	58.4
L(40)	58.2	58.0	57.9	57.9	57.7	57.7	57.2	57.2	56.9	56.7
L(50)	56.3	56.3	56.0	55.7	55.4	54.8	54.7	54.1	53.9	53.7
L(60)	53.4	53.4	53.3	53.2	52.5	52.4	52.2	52.1	52.0	51.8
L(70)	51.7	51.4	51.3	50.7	50.4	49.6	49.6	49.1	49.1	49.0
L(80)	48.6	48.6	48.5	48.4	48.3	48.3	47.9	47.5	46.8	46.6
L(90)	44.9	44.8	44.4	44.0	43.6	41.8	41.8	41.8	41.8	41.8

Start Recording

1. Connect the sound level meter to a PC via the supplied RS-232 cable.
2. Use the supplied Windows™ software to activate communication.
3. Set the sampling rate and the measurement time in the supplied software. The meter can now record remotely (disconnected from the PC) at the rate selected.
4. Press the RECORD/ERASE key to put the meter in Record Standby. The RECORD display icon will appear on the display.
5. Press the RUN/PAUSE key to start data recording. The RECORD icon will flash once per second. One reading will be stored for each sampling interval (set in the sampling rate parameter above).
6. When the measurement time expires, the meter stops recording and the RECORD display icon switches off.
7. The recorded data can then be down-loaded to the PC using the supplied Windows™ software.

Erasing Records

1. When the meter's memory is full, the FULL display icon will appear on the display.
2. Press and hold the RECORD ERASE key for 3 seconds to erase all records. The FULL display icon will switch off when the data is cleared.

Specifications

General Specifications

Applicable Standards	IEC 651 / 804 type 2 and ANSI S1.4 type 2
Measurement types	SPL, SEL, Leq, MAX-L, and MIN-L
Measurement range	30 to 130dB
Frequency Range	31.5Hz to 8kHz
Frequency weighting	'A' and 'C'
Response time	FAST, SLOW, and IMPULSE selections
Linearity range	100dB
Display resolution	0.1dB
Accuracy	±1.5db (94dB @ 1kHz)
Microphone	0.5" Electret Condensator
Numeric Display	4-digit LCD
Display update rate	Twice per second
Bargraph Display	4dB per step (over 100dB range) with 50 segments
Bargraph update rate	16 times per second
Display warnings	'OVER' and 'UNDER' range status indicators
Analog outputs	DC: 10mV per dB; AC: 2Vrms full scale
Power supply	Four (4) 1.5V 'AA' batteries (optional AC adaptor)
Battery life	20 hours (approx.)
Operating conditions	41 to 104°F (5 to 40°C); 90% Relative Humidity
Storage conditions	14 to 140°F (-10 to 60°C); 75% Relative Humidity
Dimensions	10.4 x 2.8 x 0.8" (265 x 72 x 21mm)
Weight	Approx. 10.9 oz. (310g)

Supplied Material

- Adjustment screwdriver
- Batteries (four 'AA' 1.5V cells)
- Operation Manual
- CD with Windows™ Software and software manual
- RS-232 Interface cable
- Windscreen
- 3.5mm plug for analog output access

Warranty

EXTECH INSTRUMENTS CORPORATION warrants this instrument to be free of defects in parts and workmanship for **one year** from date of shipment (a six month limited warranty applies to sensors and cables). If it should become necessary to return the instrument for service during or beyond the warranty period, contact the Customer Service Department at (781) 890-7440 ext. 210 for authorization or visit our website www.extech.com for contact information. A Return Authorization (RA) number must be issued before any product is returned to Extech. The sender is responsible for shipping charges, freight, insurance and proper packaging to prevent damage in transit. This warranty does not apply to defects resulting from action of the user such as misuse, improper wiring, operation outside of specification, improper maintenance or repair, or unauthorized modification. Extech specifically disclaims any implied warranties or merchantability or fitness for a specific purpose and will not be liable for any direct, indirect, incidental or consequential damages. Extech's total liability is limited to repair or replacement of the product. The warranty set forth above is inclusive and no other warranty, whether written or oral, is expressed or implied.

Calibration and Repair Services

Extech offers repair and calibration services for the products we sell. Extech also provides NIST certification for most products. Call the Customer Service Department for information on calibration services available for this product. Extech recommends that annual calibrations be performed to verify meter performance and accuracy.



Support line (781) 890-7440

Technical support: Extension 200; E-mail: support@extech.com

Repair & Returns: Extension 210; E-mail: repair@extech.com

Product specifications subject to change without notice

For the latest version of this User's Guide, Software updates, and other up-to-the-minute product information, visit our website: www.extech.com
Extech Instruments Corporation, 285 Bear Hill Rd., Waltham, MA 02451

Copyright © 2005 Extech Instruments Corporation

All rights reserved including the right of reproduction in whole or in part in any form.